

Bernhard S. Müller's instructions and analysis of

Solar Funnel Cookers



Title photo: Multiple oval shaped reflections of the cooking container prove that the funnel cooker is well constructed and perfectly positioned toward the sun.

Many high-ranking and well-known scientists and constructors like Teong Tan (Singapore), Celestino Ruivo (Portugal), Juan Bello (Spain), Elmo Dutra (Brazil) and Steven Jones (USA) lost their heart to designing funnel cookers.

Funnel cookers are among the easiest-to-make panel cookers. A rather large aperture area in combination with a good reflective material results in successful solar cooking and baking up to a mass of approximately 4 kg (1 US Gallon) as long as the sky is clear.

The existing cookers come in various sizes. This explanation describes a side length of 60 cm to fit postal shipping regulations so you don't have to pay a bulk surcharge.

Further advantages of funnel cookers:

- Operation even at low sun angles.
- Easy to build, set up and handle.
- Easy to store and transport.
- Very low construction costs.
- Higher wind stability than most panel cookers, even smaller ones.

Construction and understanding

When you set up a funnel cooker for the first time, it may appear cumbersome. But with some practice, usually after the second or third time, you will find it easy.

The materials you need to build a funnel cooker are:

- 2 cardboard or polypropylene (PP) sheets of 85 cm x 60 cm
- 2 reflective sheets of the same size, like aluminium, Mylar, S-ReflecT or similar
- 95 cm of rigid textile reinforced tape to connect both halves
- glue (or double-sided adhesive tape) to stick the reflective sheets onto the cardboard or PP.

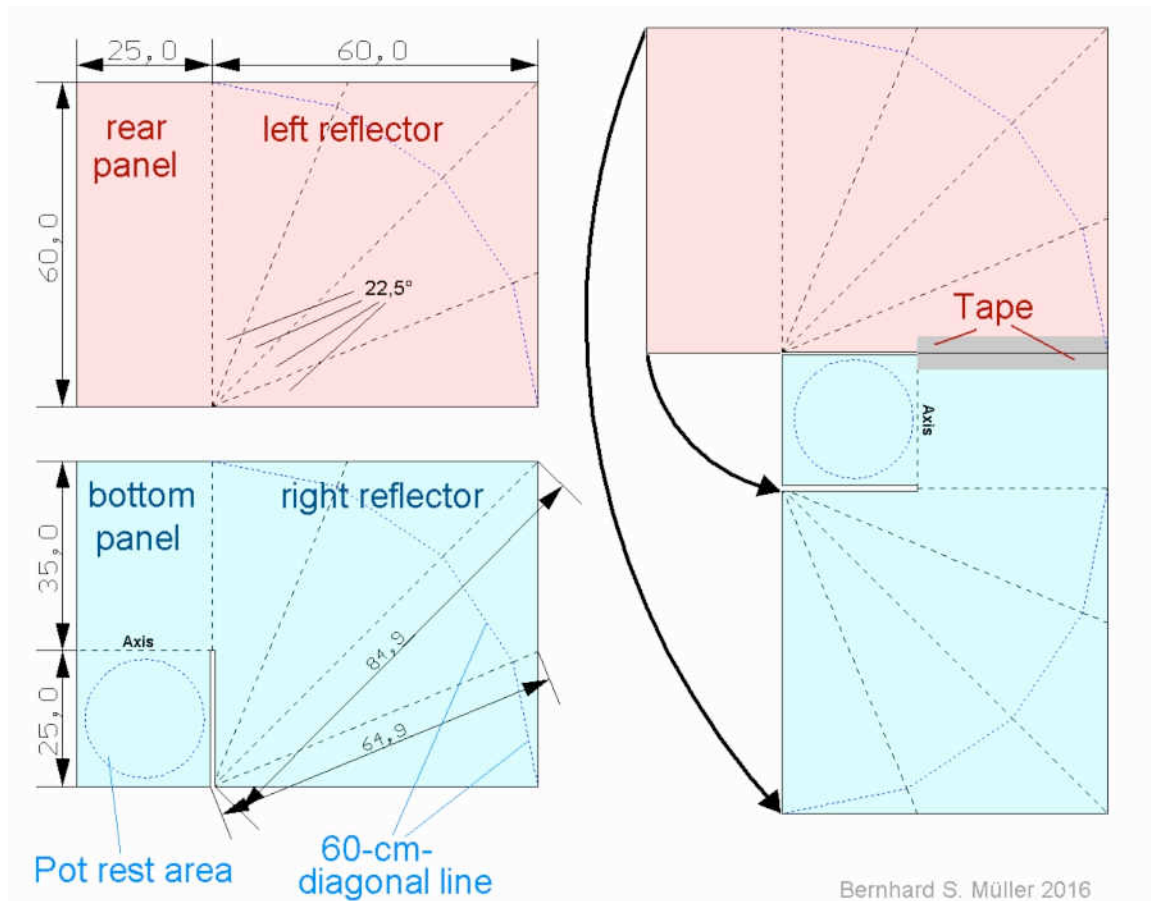

Sketch 1: Cut two sheets of 85 x 60 cm as shown above. Press notches along the dotted lines for easy and precise folding of cardboard and reflector. One of the sheets needs additional notches at the "axis" so the funnel cooker can be tilted according to the elevation of the sun during operation. Glue the reflective material on the cardboard first. Then join both halves together with strong tape for durable use. The cardboard structure will follow your movements automatically, provided the notches are in a straight line and deep enough.

Carefully press or scratch the notches with a blunt piece of metal, e.g. a spoon. Do not use scissors or knives as they may damage the material! The notches need to be completely straight. Therefore you should use a ruler or a similar item. The angles between the notches should be exactly 22.5°.

There are many ways to obtain an angle of 22.5°, which is half of 45°. An example is shown in Sketch 3: Draw the "60 cm diagonal line" on your cardboard and draw marks for the notches every 23.4 cm. (Please feel free to proceed your own way if you prefer a different method.)

Sketch 2 (right) and 3 (below) show several ways to create an angle of 22.5°. The side length of the square remains 60 cm.

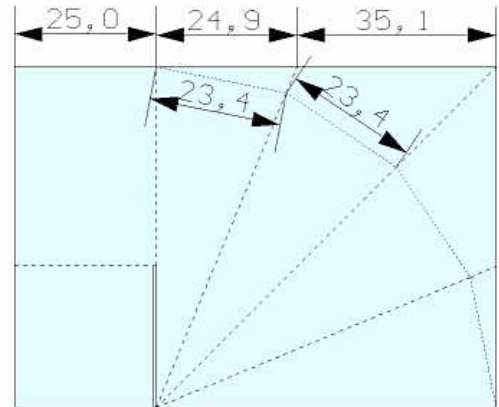
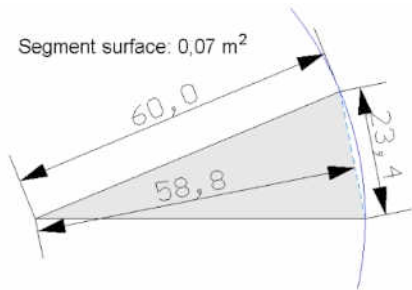

Calculation of the Aperture Area

You can skip this paragraph and come back to it later in case you find it too complicated right now.

The best way of calculating the aperture area is by constructing a 3-D-model of the funnel cooker. That way you will obtain all other data.

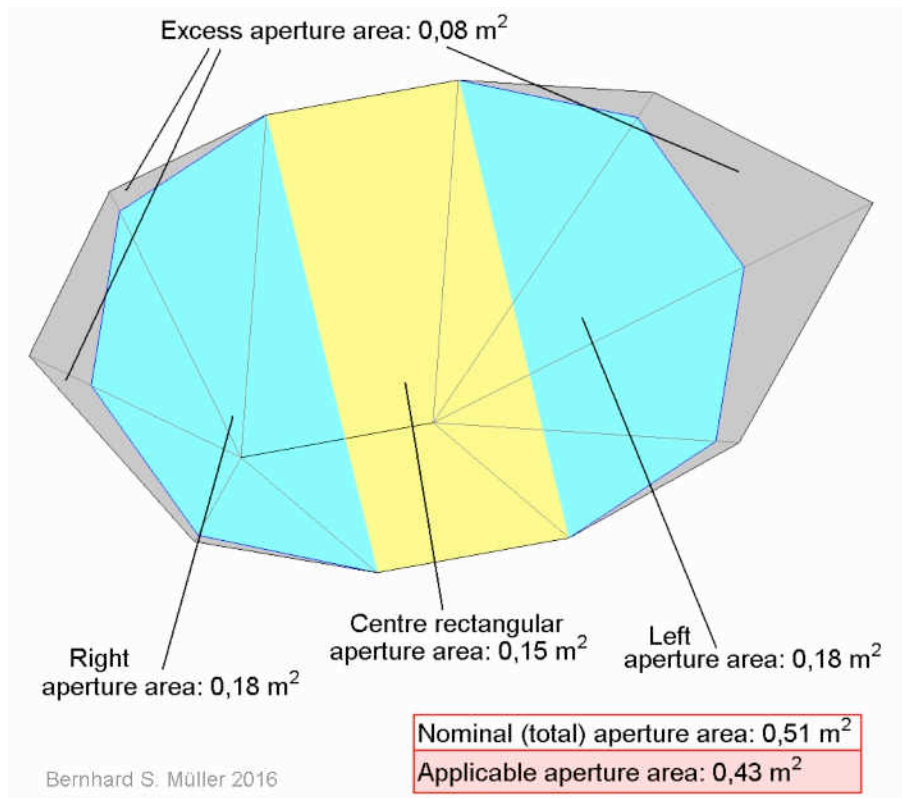

Sketch 4: The aperture area determines not only the received solar power but also the wind vulnerability. The dark-shaded excess aperture area represents the so-called parasitic mass. It is of no use. If you want, you can cut it off and save a little bit of weight.

Sketch 5: Calculate triangles for every edge - five of them on both lateral halves of the funnel cooker. Sketch 3 shows the side lengths of the edges.

The lower angle of every triangle is 30° . The opposite triangle is the same, thus the opening angle of the funnel cooker is 60° .

The calculation is quite simple if you apply the rule of Pythagoras : $c^2 = a^2 + b^2$. For your convenience, you can find the rules for a rectangular triangle in the inserted box.

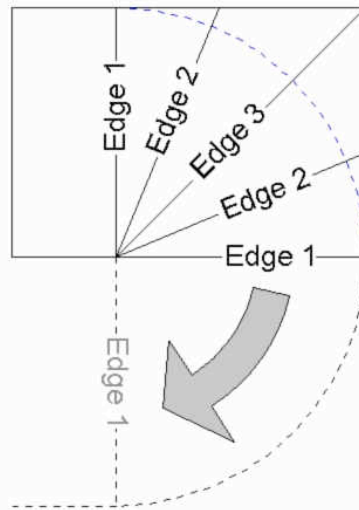

Rules of a right-angled triangle:

$\gamma = 90^\circ$
 $c^2 = a^2 + b^2$
 $\tan \alpha = a : b$

In this example the angle $\alpha = 30^\circ$

Bernhard S. Müller 2016

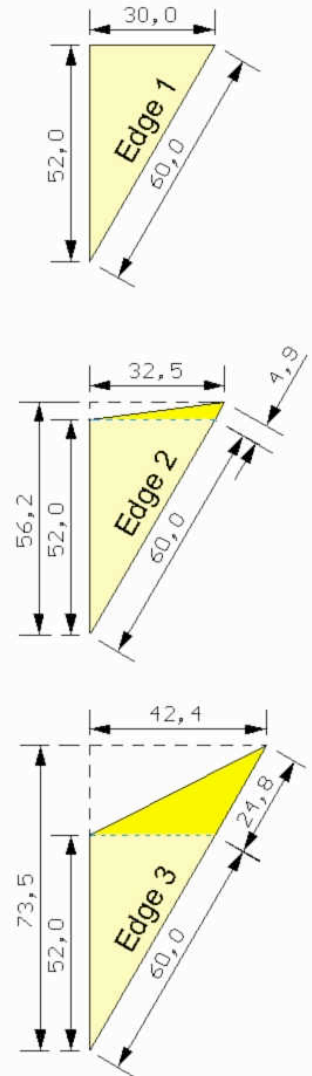

By bending the funnel you will position both edges with the number 1 opposite. By stretching a $1/4$ -circle to a $1/2$ -circle, all 22.5° centre angles will double to 45° . This step is explained in the top left drawing of Sketch 5.

To calculate the applicable aperture area - without the parasitic mass - please proceed as follows:

The centre panel rectangles add up to 0.15 m^2 .

The lateral halves shape a circle of 30 cm radius which is calculated $r^2 \cdot \pi$ to get the area. The result is 0.2827 square meters.

Total applicable aperture area: $0.15 \text{ m}^2 + 0.2827 \text{ m}^2 = 0.4327 \text{ m}^2$.

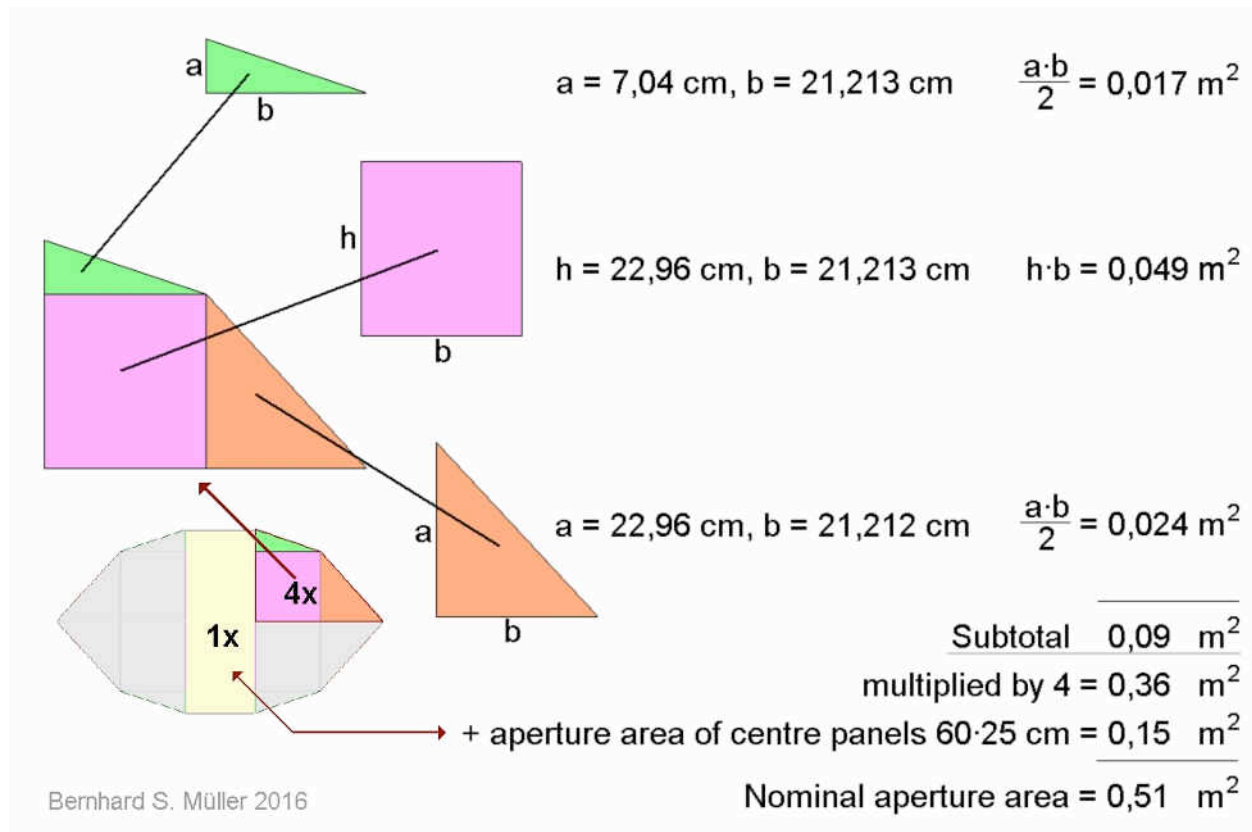

Sketch 6 (above): One quarter of the aperture area is 0.09 m² and needs to be multiplied by 4 to include all of them in the results. Then add the aperture area of the centre panels to obtain the entire nominal aperture area including the before-mentioned parasitic mass.

Sketch 7 (right): A solar cooker (view silhouette) does not necessarily have to look sober and strictly technical. Please feel free to decorate it according to your phantasy and talent.

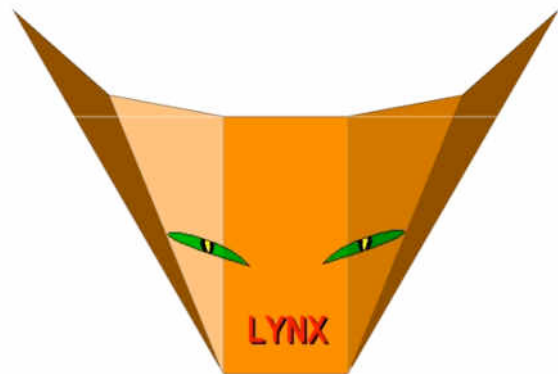

Construction with a CAD programme

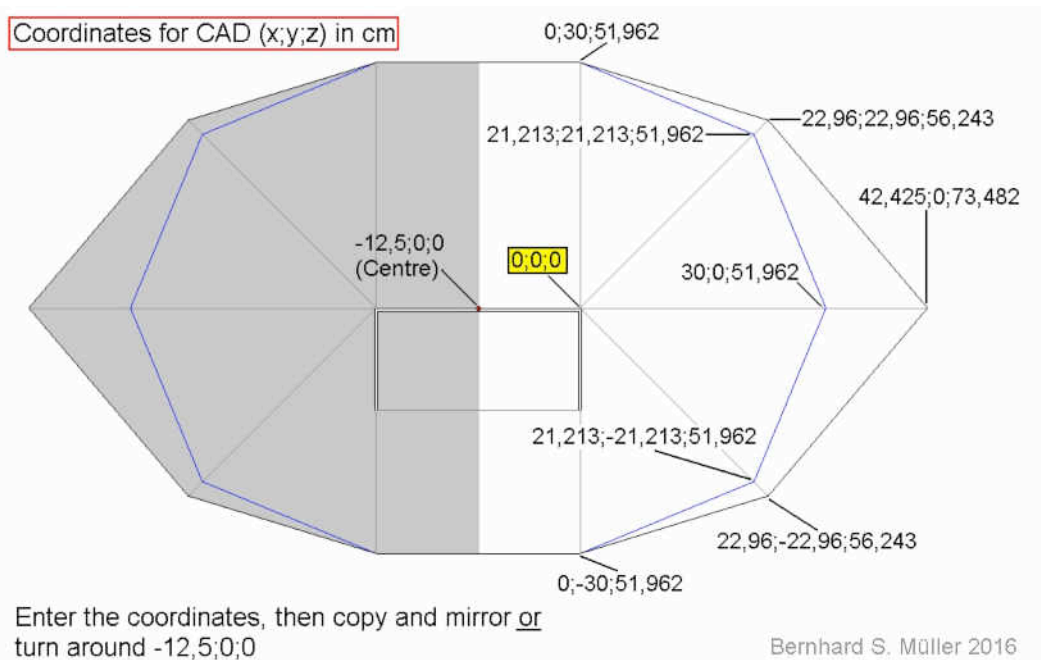

Sketch 8: The coordinates represent the dimension on the x-, y- and z-axis. Example: 30;0;51,962 means 30 cm horizontal to right, 0 cm vertical and 51.962 cm deep. This CAD programme separates the values by semicola and determines each dimension with decimal commata. That's why you can find both, decimal commata and decimal points in this description.

Positioning the funnel cooker

To track the sun, the solar funnel cooker has to be re-positioned after every 40 minutes at the latest. Within this period the sun moves at an angle of about 10°. Consequently, the sun moves 15° every hour along its seasonal path. The movement is horizontal and vertical simultaneously. The horizontal position of the sun is called Azimuth (degrees from north via east). The vertical position is called Sun Angle. Example: if the sun rises at 6:00h exactly at East, the Azimuth is 90° and the Sun Angle is 0°. At solar noon the Azimuth is 180° and at sunset it is 270°. These data vary for every place on our planet earth because it is round and travels on an elliptic path around the sun.

To detect the true south, either use a compass on your smartphone or obtain the 3-D solar tracking App "Sun Surveyor" free for every common OS.

During a cooking session you have to:

- Turn the support block of the funnel cooker - see note underneath *)
- Tilt the funnel cooker up (before noon) or down (in the afternoon).
- Put the anchor stones in place to stabilize the funnel cooker. Take the wind conditions into consideration as well.

*) Move the anchor stones closer to the support block before turning it to avoid too much tension on the strings.

Vertical adjustments

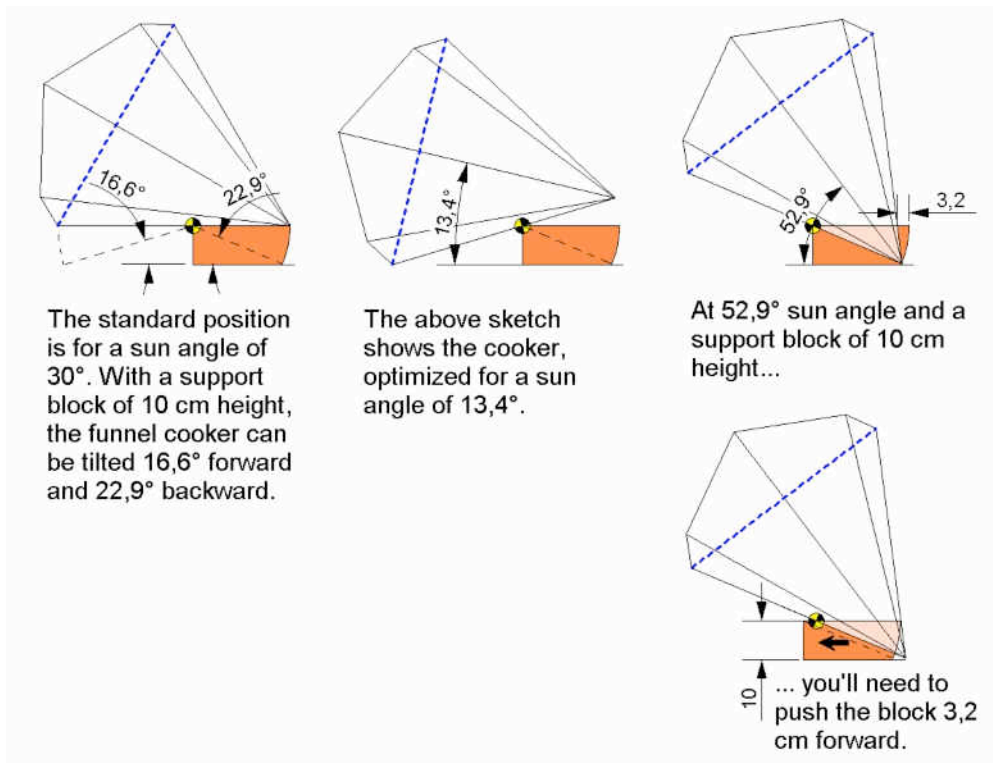

Sketch 9 (above) explains how to tilt the funnel cooker up to a sun angle of 52.9°

Sketch 10 (right): If in the place of operation you mainly have higher sun angles, the support block must be higher than 10 cm. Please make use of the suggestions on the sketch or feel free to design your own support

The pot rest panel needs to be folded up at the rear end to fit smoothly inside the funnel. If this is too cumbersome for you, just cut 4 cm off the rear edge as shown in Sketch 13. (25 cm minus 21 cm = 4 cm).

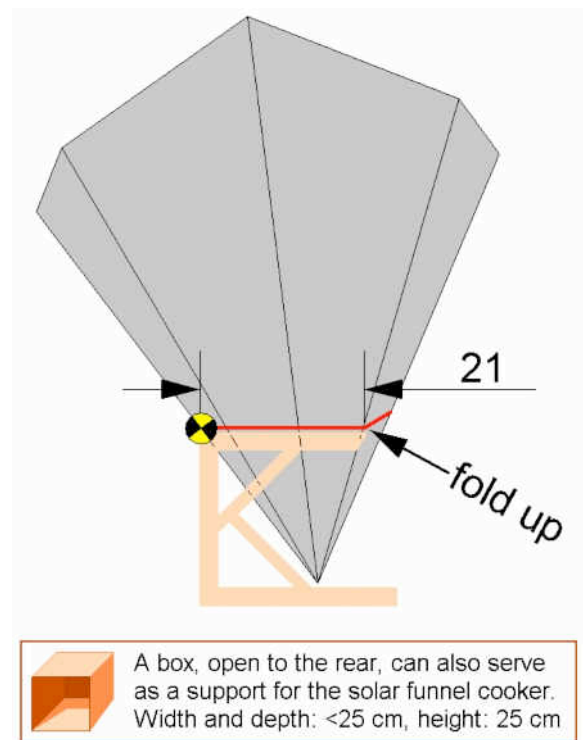

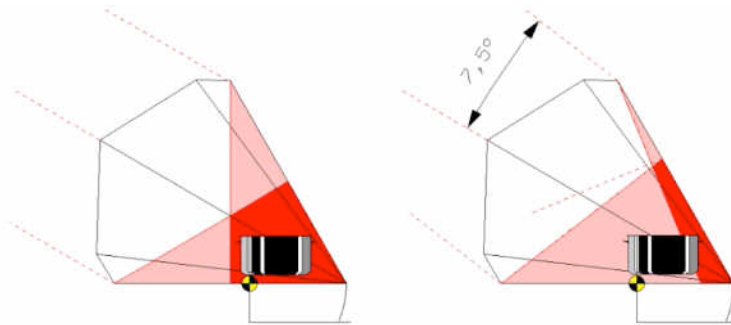

Sketch 11: The reflections clearly indicate that the panel cooker needs to be adjusted after one hour at the latest. It is recommendable to do so after every 40 minutes. The sun moves 15° within one hour. Hence, you need to shift it some degrees "forward" and repeat it after 40 minutes. Just for your full information: the opening angle of the funnel cooker is 60° . The relatively short repositioning periods are probably the only disadvantage of the funnel cooker in comparison with other panel cookers.

Horizontal adjustments

The solar funnel cooker needs to be repositioned and secured with anchor stones according to following sketch:

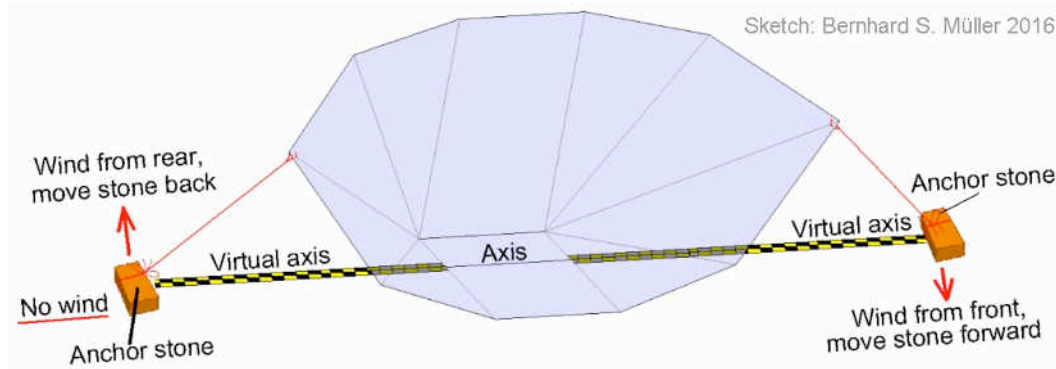

Sketch 12 explains the position of the anchor stones, e.g. bricks. They spread the funnel cooker to its ideal aperture area and stabilize it.

Variations

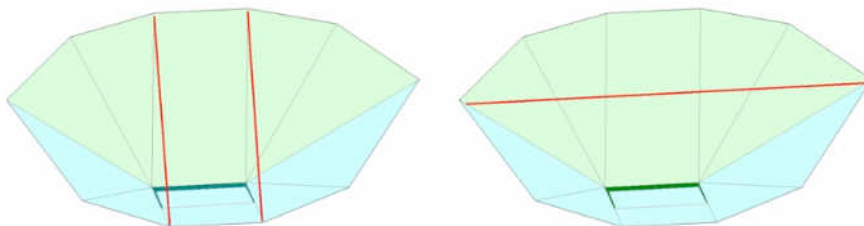

Sketch 13: If you do not want to use stones, you can spread the funnel cooker with rods. However, this method is not recommendable because it decreases the wind stability.

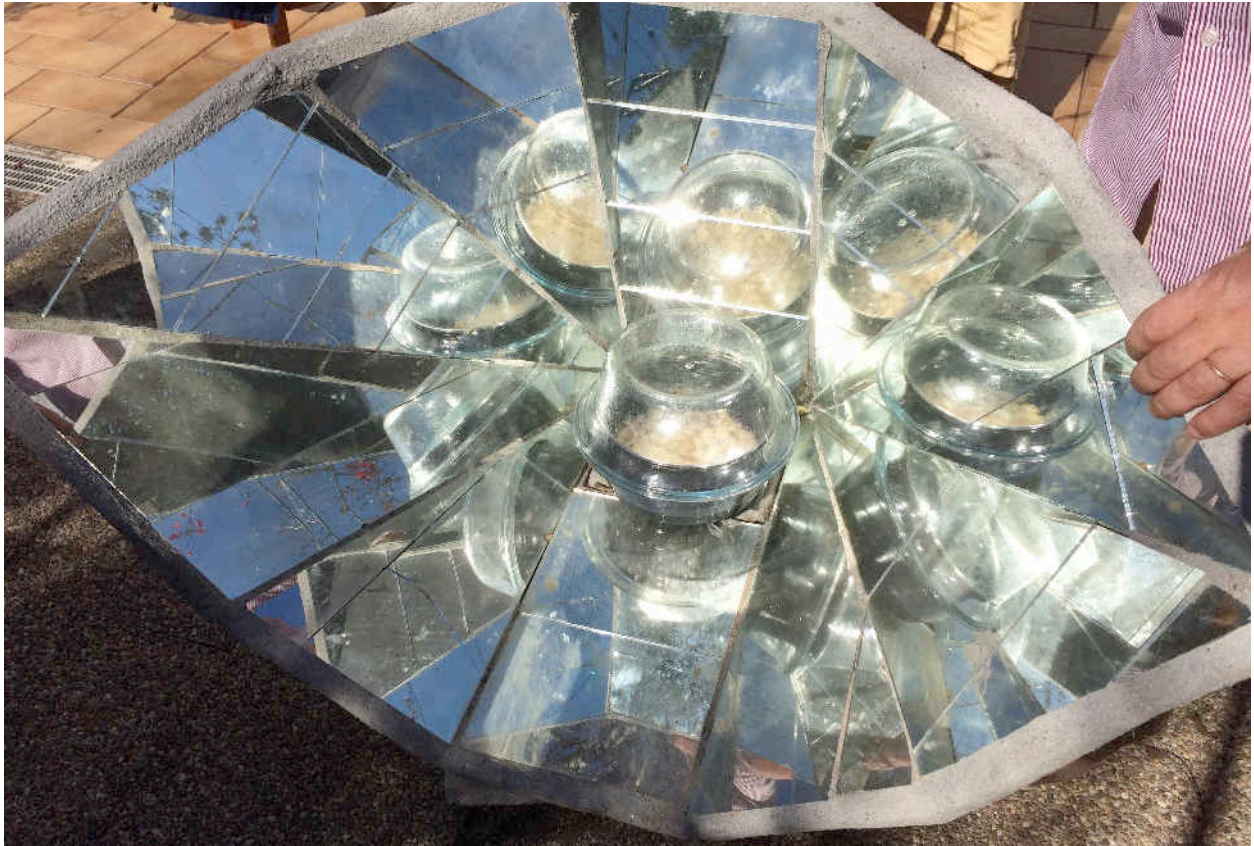
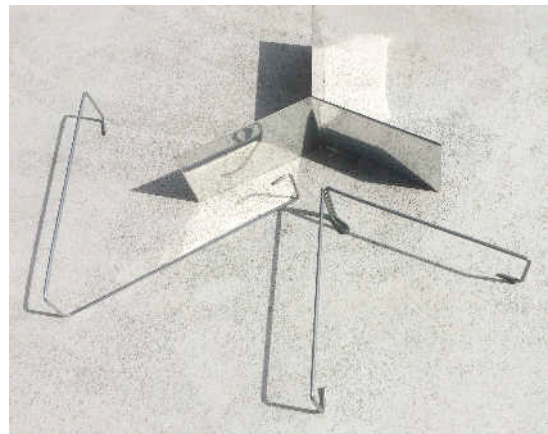

Photo 2: A funnel cooker made of concrete by Celestino Ruivo, Portugal, It can be left outside throughout the year. A weight of 80 kg protects these models from theft.

Trivets, Pot Elevations and Heat Traps

Solar cookers have been categorized as concentrating types (parabolic or Fresnel), box cookers and panel cookers. Funnel cookers belong to the large panel cooker family. All of these, without exemption, need a heat trap and a device to elevate the pot to enable the reflected radiation to reach the pot from underneath in order to obtain additional energy.

Photo 3: Three trivets especially designed for panel cookers. The two in front are made of the bent wires of a coat hanger. The rear one is made of a strip of polished metal.



Many people use Polyester oven bags as greenhouse enclosures to trap the infrared radiation.

Put a trivet and a pot into a bag, close the bag with a cord or ribbon and place it in the rear part of the bottom panel, just next to the notch described as "axis" (see also Sketch 11).

A more durable and elegant method is a heat trap made of glass: try to obtain 2 windows of recycled front-loader washing machines as shown on photo 4 (right). You can see the trivet underneath the pot.



Temperatures

When the sky is clear, the stagnation temperature in the cooker is usually about 150°C which is high enough to get most cooking and baking tasks accomplished. Frying, however, is not possible. The time to reach and hold the maximum temperature depends on the mass of food.

The energy you need to heat food which contains high amounts of water up to the boiling temperature is determined by the formula

$$Q = c \cdot m \cdot \Delta T$$

Q: required energy in kJ

c: specific heat capacity (water: 4.186 kJ/(kg · °C)

m: mass in kg

ΔT: temperature difference between initial and final temperature in °C or K. The variation $T_2 - T_1$ is applied often. T_1 represents the initial temperature, T_2 the final temperature.

To understand the cooking process entirely, you need to know that a number of factors lead to heat loss:

- Low reflectivity coefficient of the reflector material
- Convection losses within the heat trap
- Vaporization losses
- Convection losses at the outside of the heat trap due to temperature difference and wind conditions
- Losses due to emitted radiation (absorptivity coefficient = emissivity coefficient)
- Atmospheric losses, like scattering and absorption of the radiation, especially due to low sun angle and/or polluted air

Sketch 14: The panel cooker folds easily for storage and transportation.

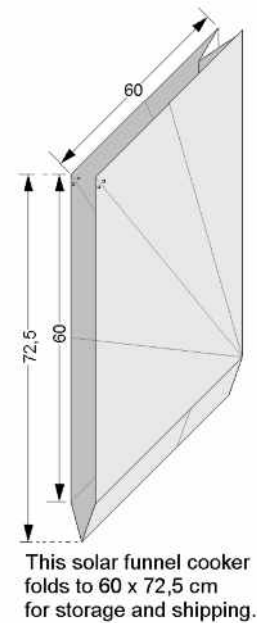

You are welcome to visit <http://www.mueller-solartechnik.com> to obtain a multitude of valuable information free of charge. Pay special attention to the Water Boiling Test for Solar Cookers, WBTSC.

Bernhard S. Müller is the author of the following books:

Das Solarkocher-Handbuch, 240 pages, German, ISBN 978-3-8442-4471-7

Pyrolysekocher - Micro Gasifiers, 20 pages, German/English, ISBN 978-3-8442-6595-8

Die Parabel, 28 pages, German, ISBN 978-3-8442-4131-0

Publisher: epubli, Berlin, Germany

Thanks to Ingelore Kahrens, Celestino Ruivo and Zoë Williams for copy editing.

Orders from countries others than Germany cannot be placed on Amazon's international page. Please order at your bookstore or at <http://www.sun-and-ice.de>

A compilation of various solar funnel cookers can be found at <http://solarcooking.wikia.com>

Good movies about solar funnel cookers on YouTube:

Version of Celestino Ruivo: <https://youtu.be/2wmKI4I8tns>

Version of Teong Tan: <https://youtu.be/w6cVwJ2kCTM>



This information has been compiled 2016 according to the "Faro Declaration of Intent", to empower multipliers and grass-roots workers in the field of poverty-oriented energy solutions by Bernhard S. Müller, Eschborn, Germany, member of the Organisations Lernen-Helfen-Leben, Natural Resources and Waste Management Alliance, EG-Solar, SCI Association, SES Senior Experts Service and ISES. He is a member of the CONSOLFOOD organising committee.

The document may be copied and distributed freely but don't forget to mention the source. All photos by Bernhard S. Müller, <http://www.mueller-solartechnik.com>